

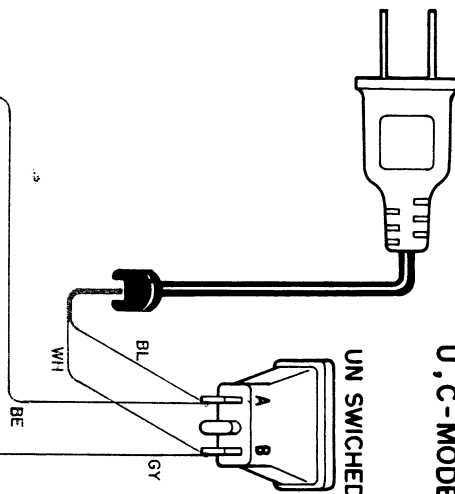

For more Hi-Fi manuals and set-up information
please visit www.hifiengine.com

WIRING DIAGRAM (Parts side)

U, C-MODELS



- U ---- USA
- C ---- Canadian
- G ---- European
- A ---- Australian
- B ---- British
- R ---- General

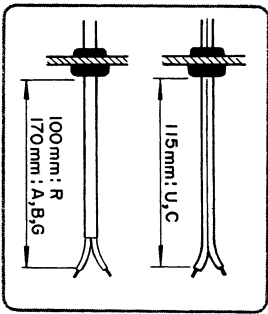

CONTROL C. BOARD (2/2)

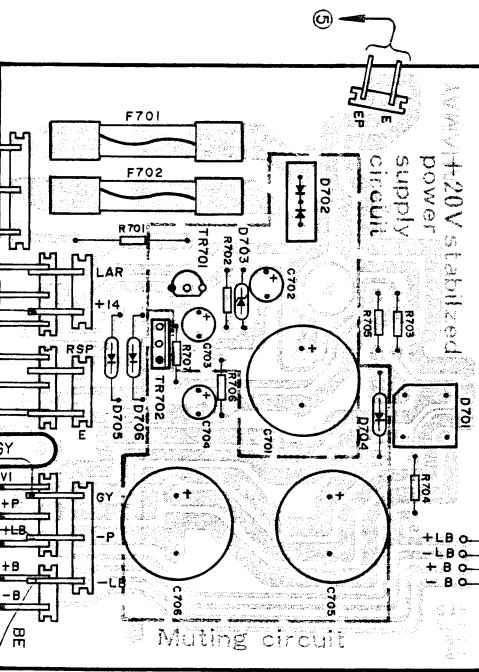
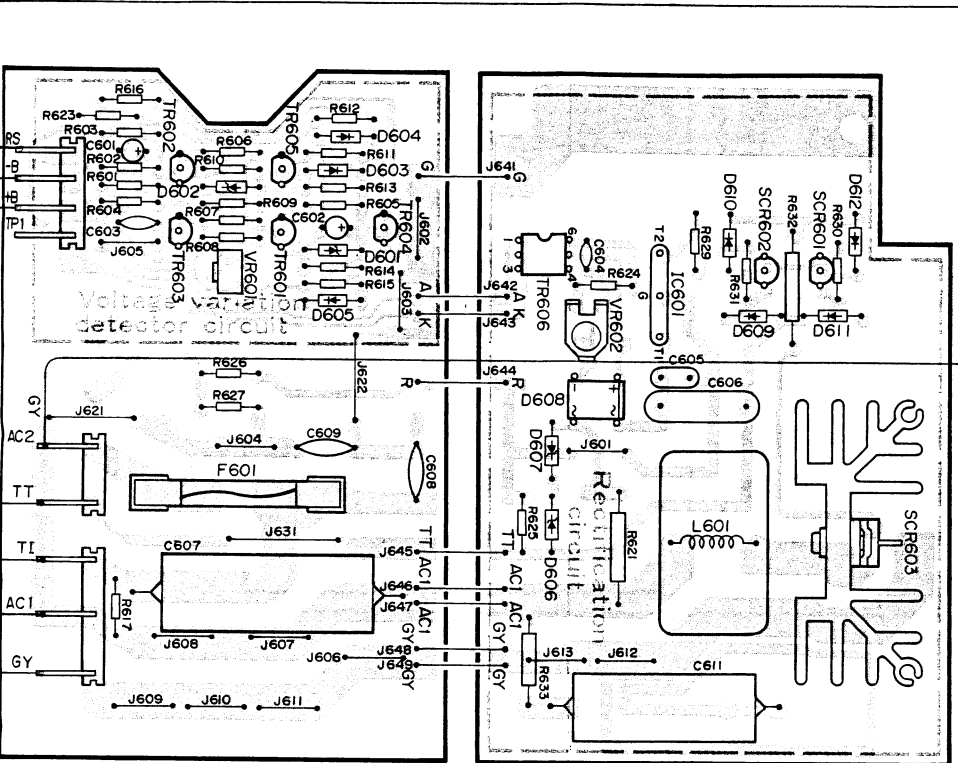

POWER
NA07760:R
NA07761:U,C
NA07762:A,B,G

F701,702	R	U, C	A, B, G
T2,5A 250V		2,5A 250V	T2,0A 250V

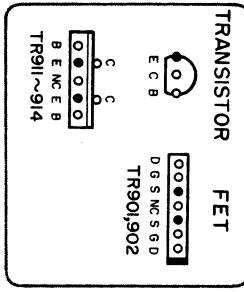
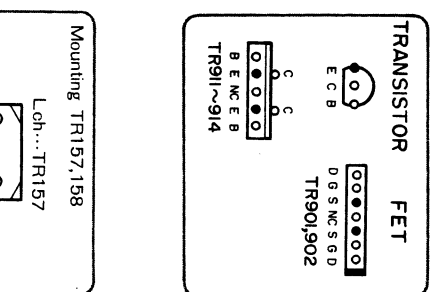
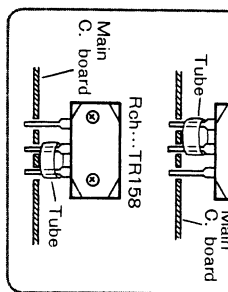
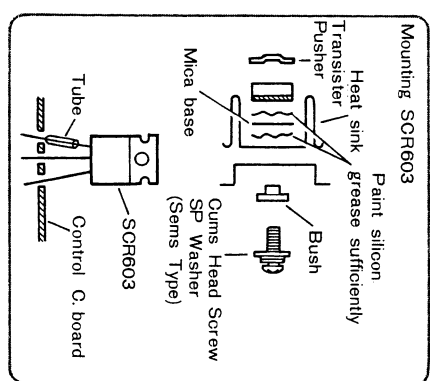
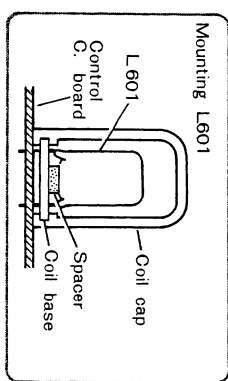

MAIN C.
NA 07752
NA 07754

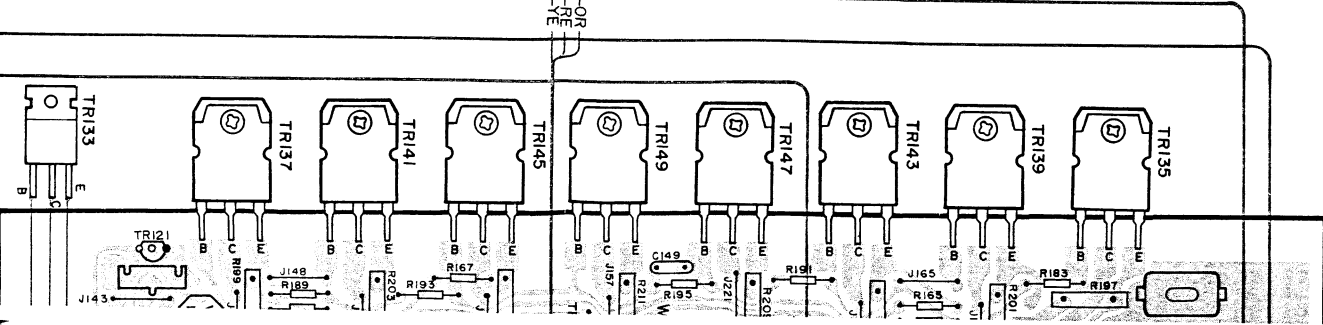

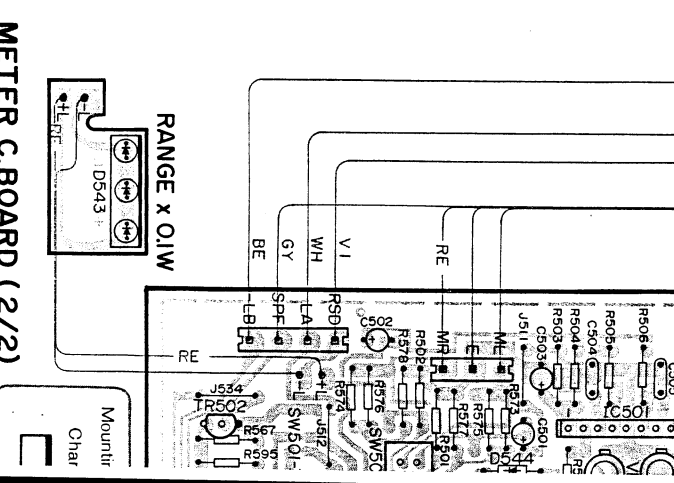
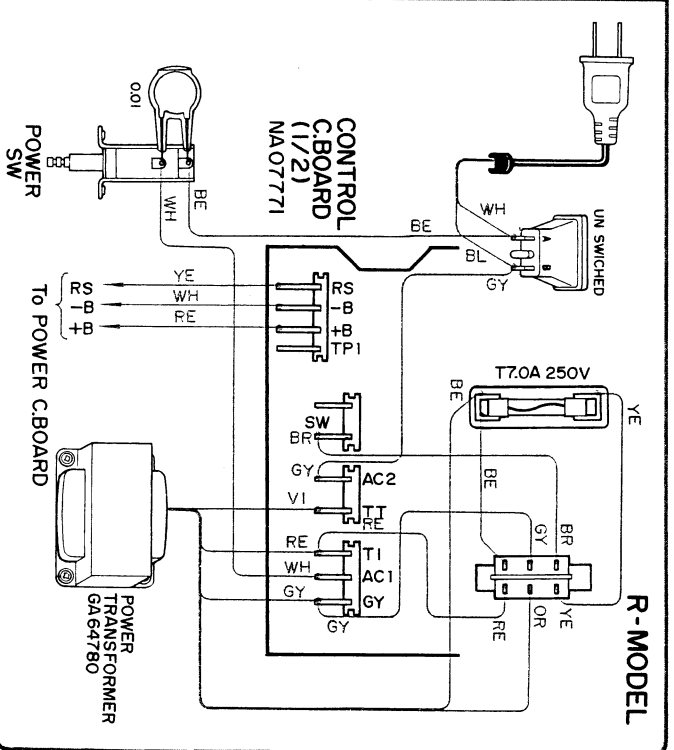
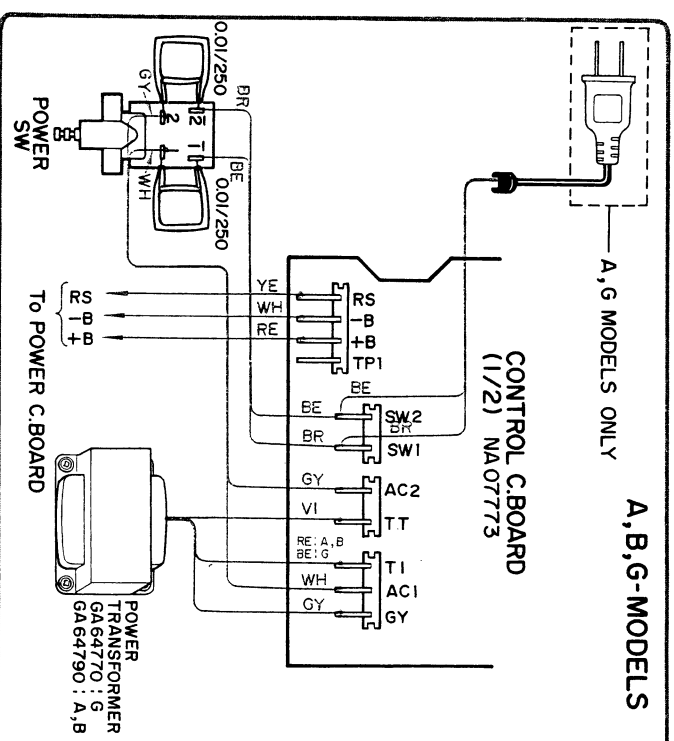
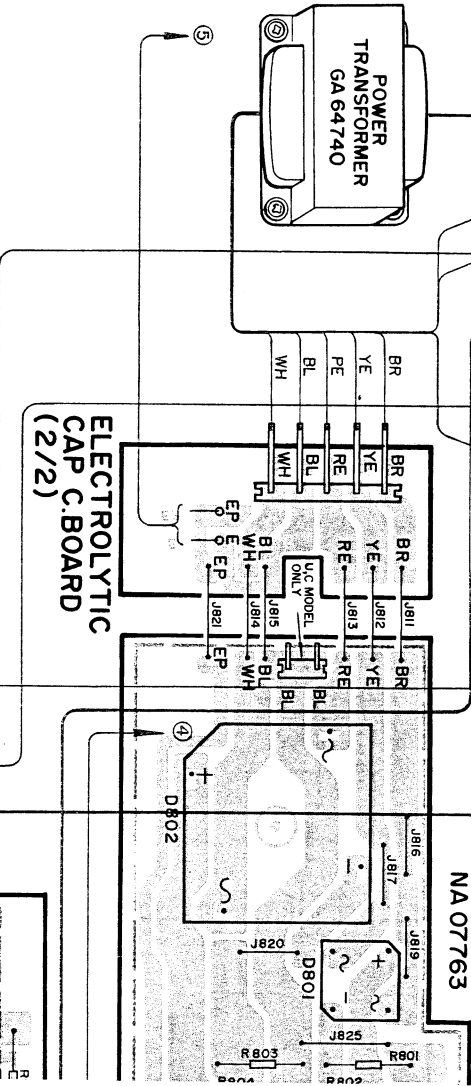
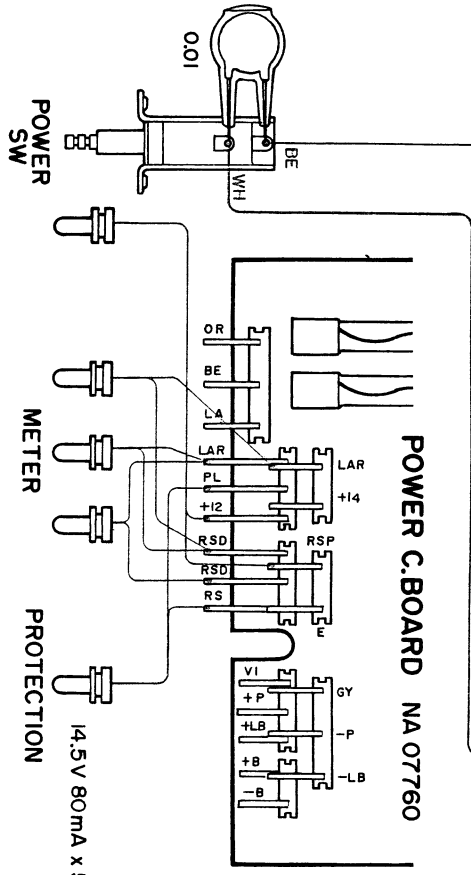
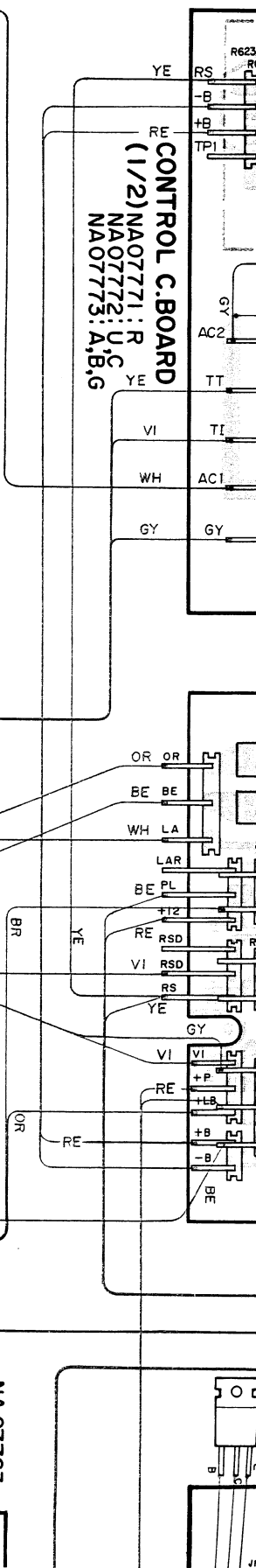

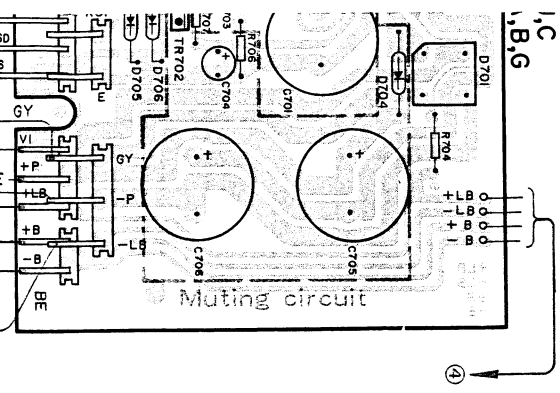
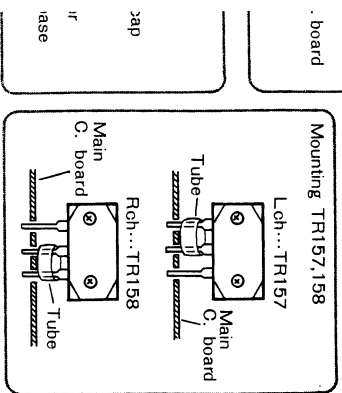
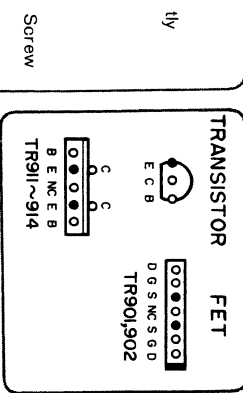

MAIN C. BOARD
 NA07753 : A, B, G, R
 NA07754 : U, C

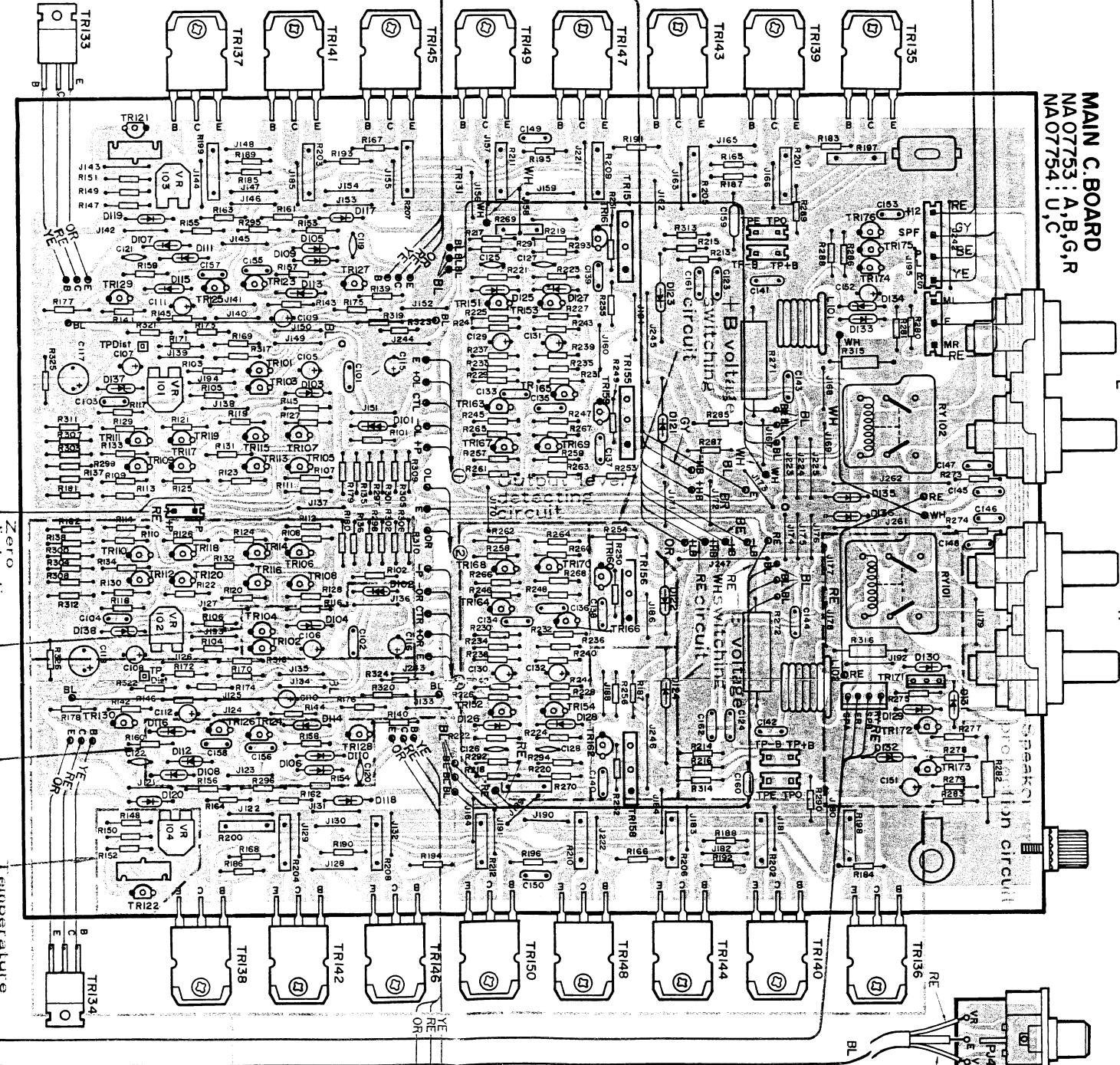

SPEAKERS

GND

INPUT

PRE DRI
 NA07785:
 NA07786:

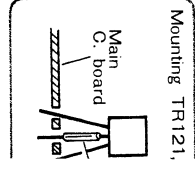
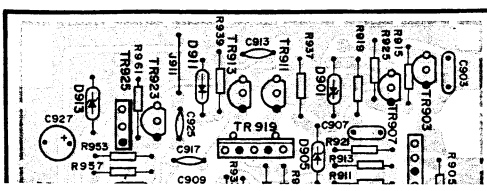

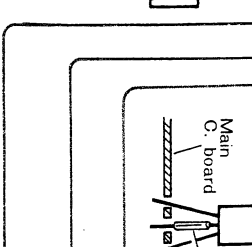
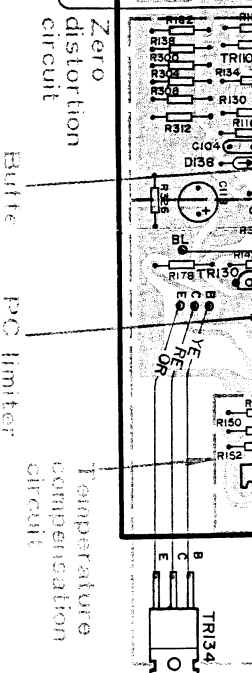
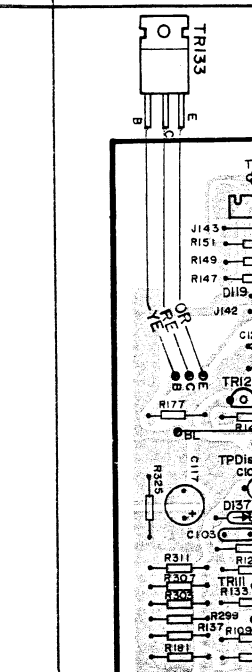
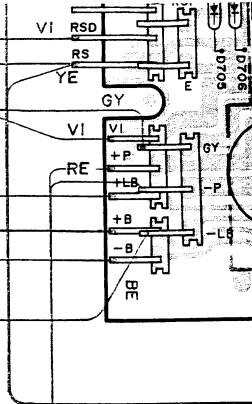

ELECTROLYTIC CAP C BOARD (2/2)

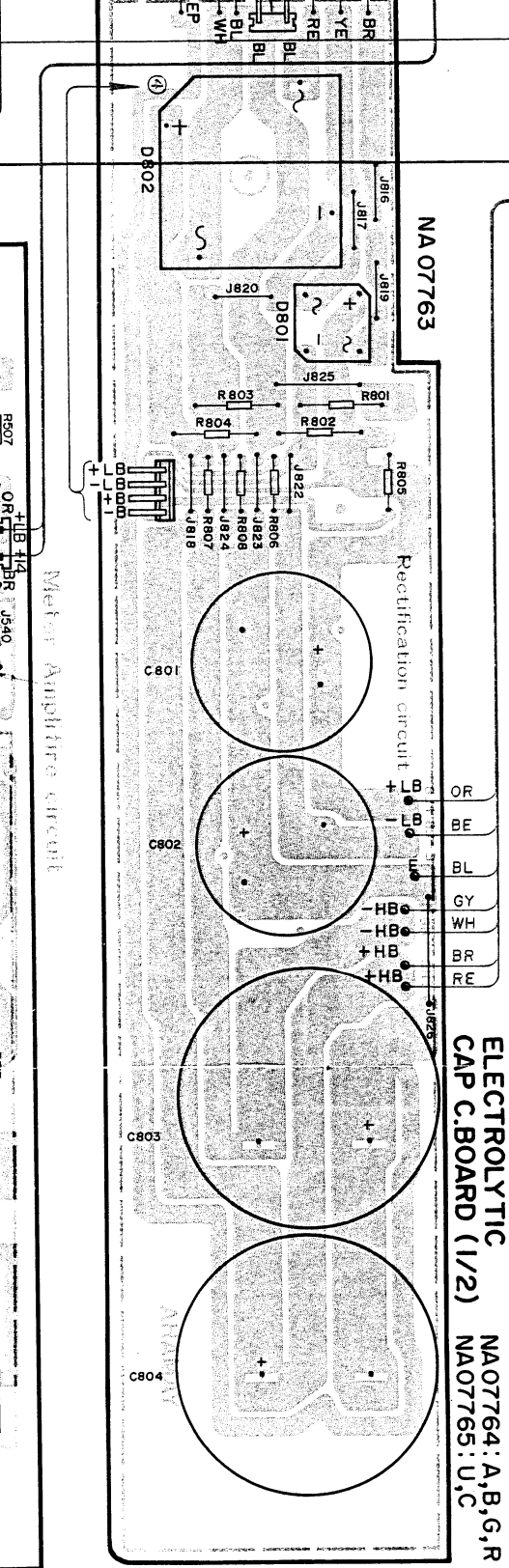

ELECTROLYTIC CAP C BOARD (1/2)

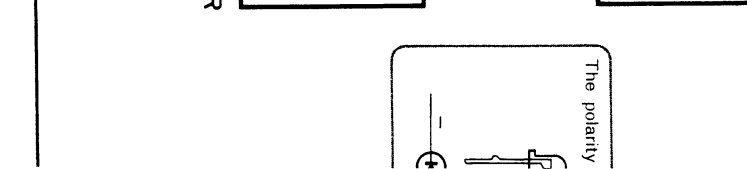
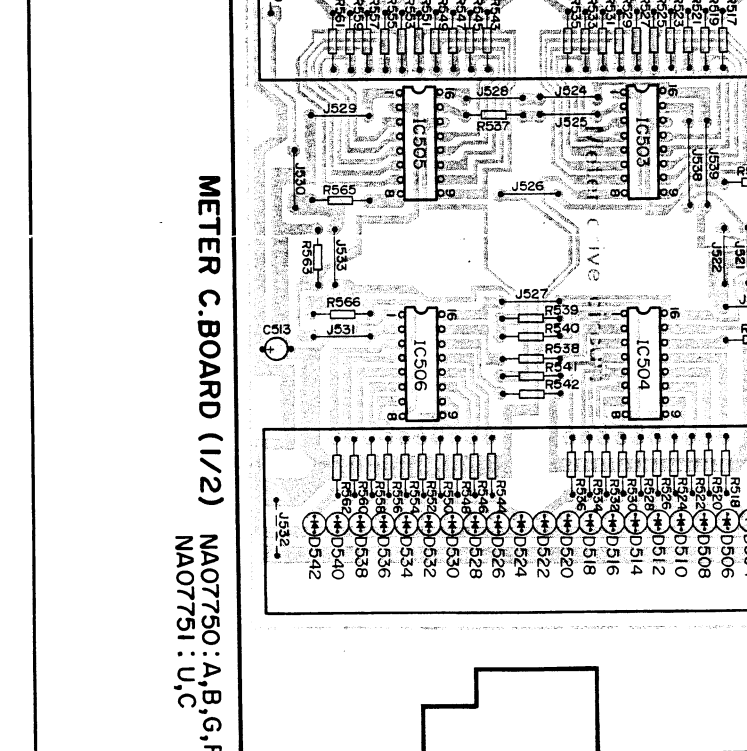
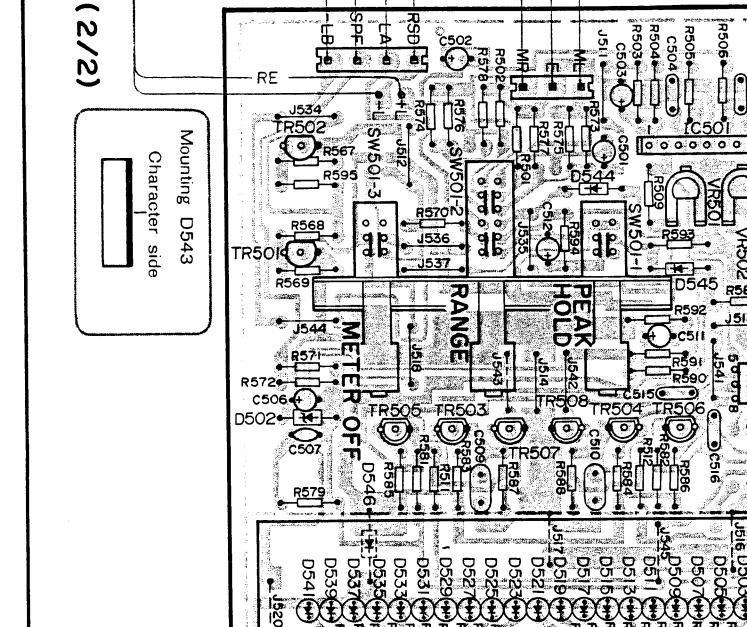
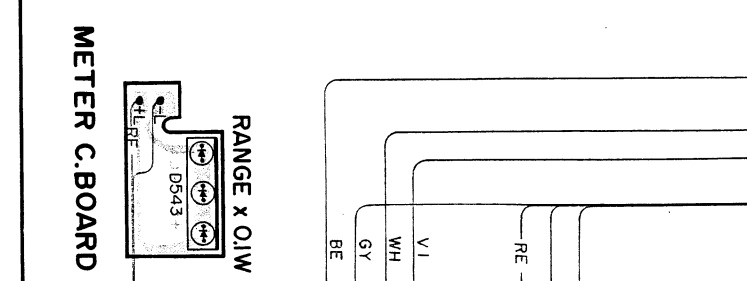
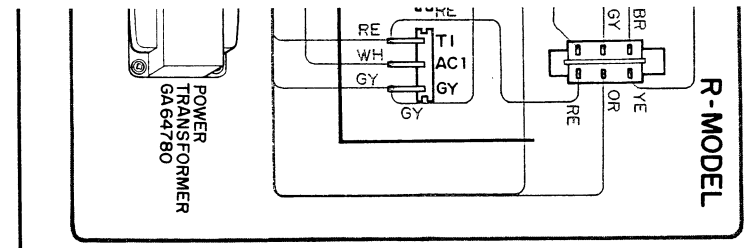

METER C BOARD (2/2)

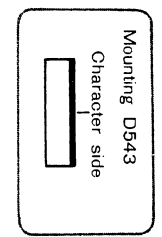

ON OF

A

B

The polarity

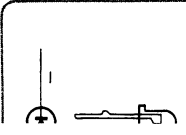

METER C BOARD (1/2) NA07750:A,B,G,R NA07751:U,C



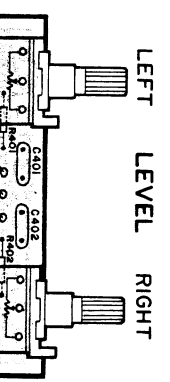
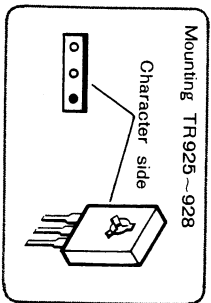
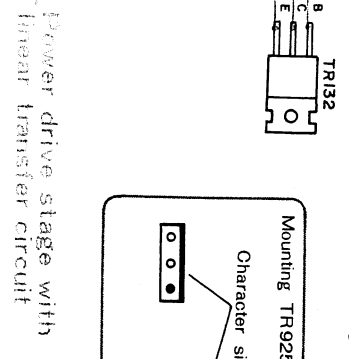
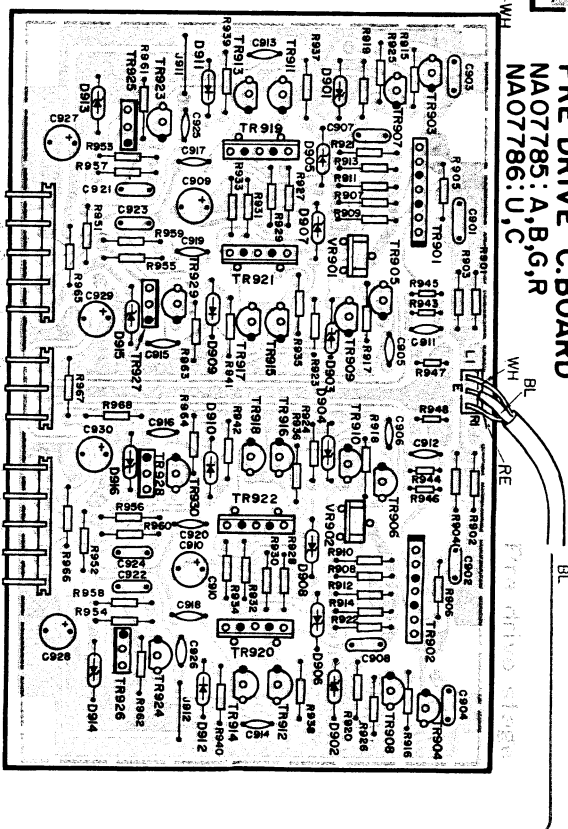
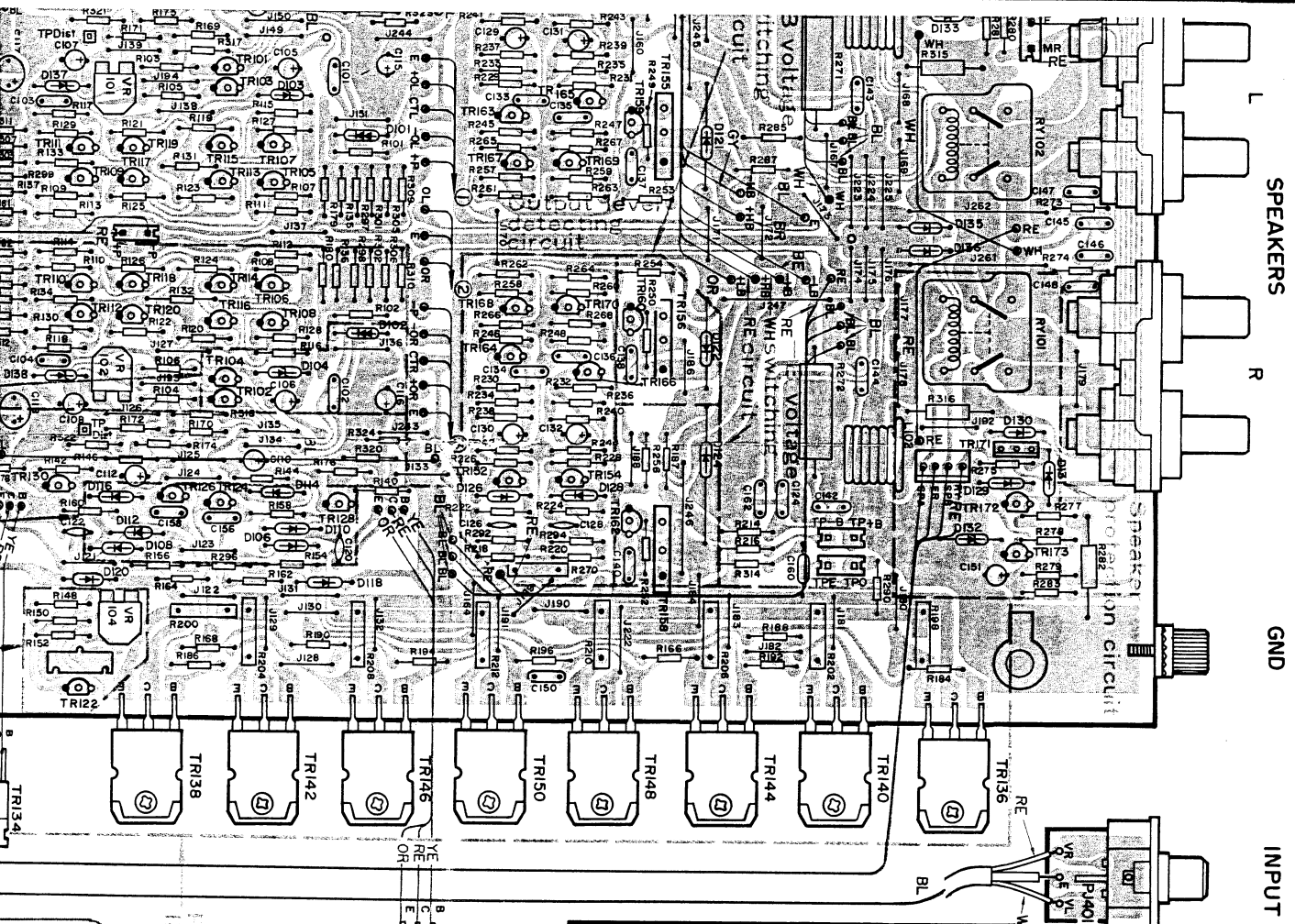

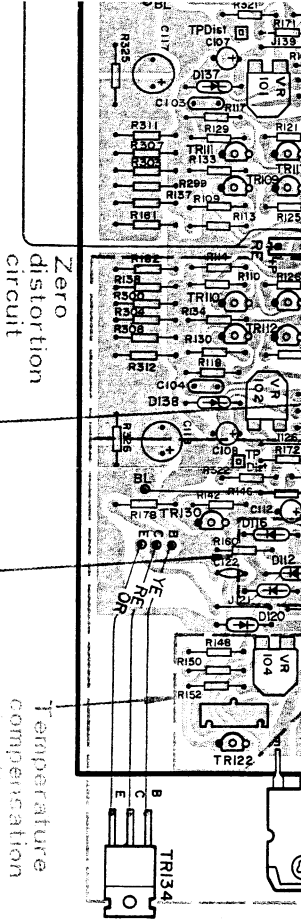

Buffer
p.c. limiter

Temperature
compensation
circuit

**ELECTROLYTIC
CAP C. BOARD (1/2)** NA07764: A,B,G,R
NA07765: U,C

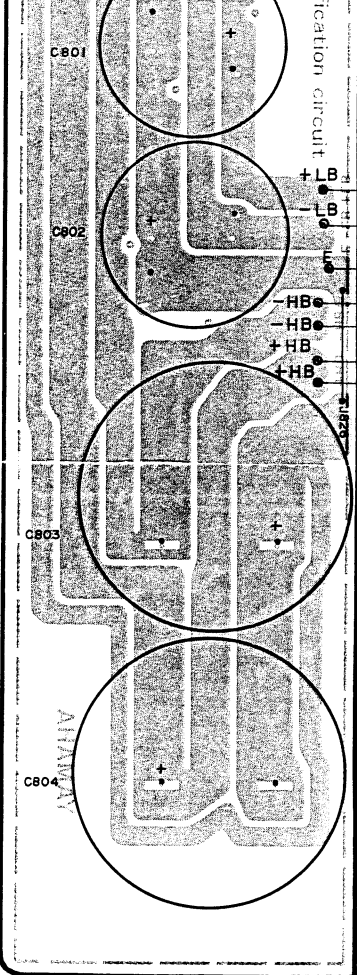

er Amplifier circuit

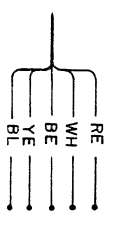
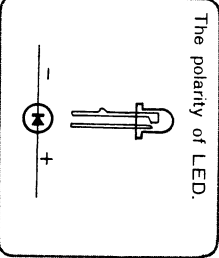
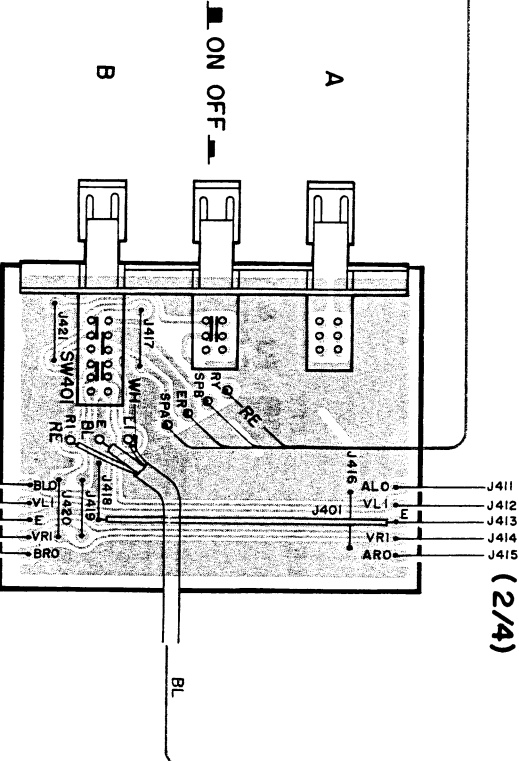
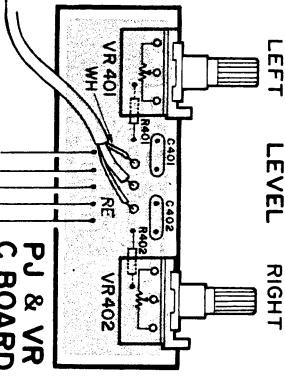
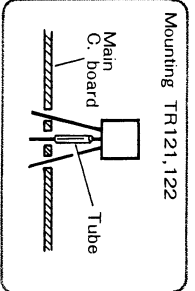
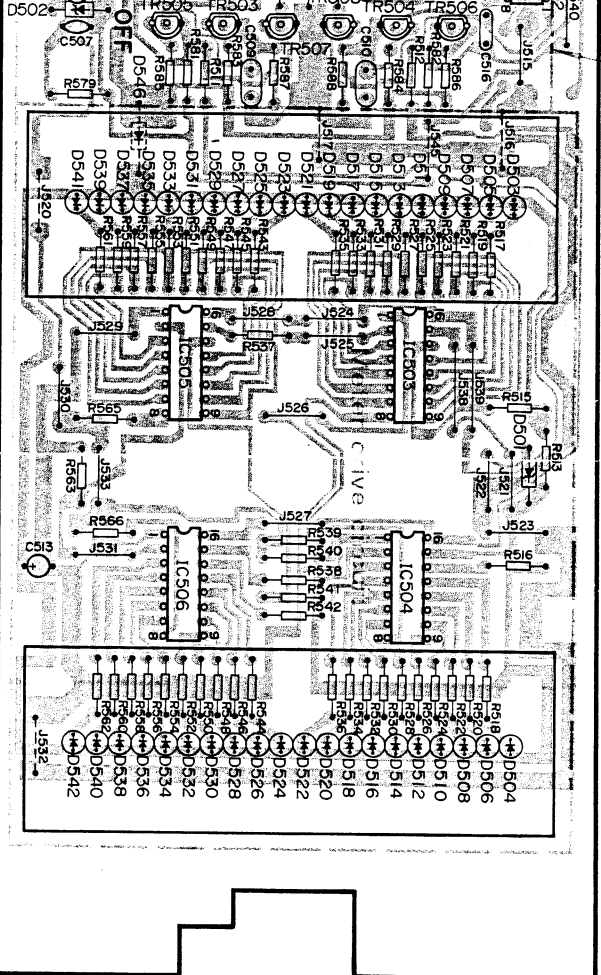

P.J. & V.R. C. BOARD (1/4) NA07908: R,U,C
NA07966: A,G,B

P.J. & V.R. C. BOARD (4/4)